

Plan.

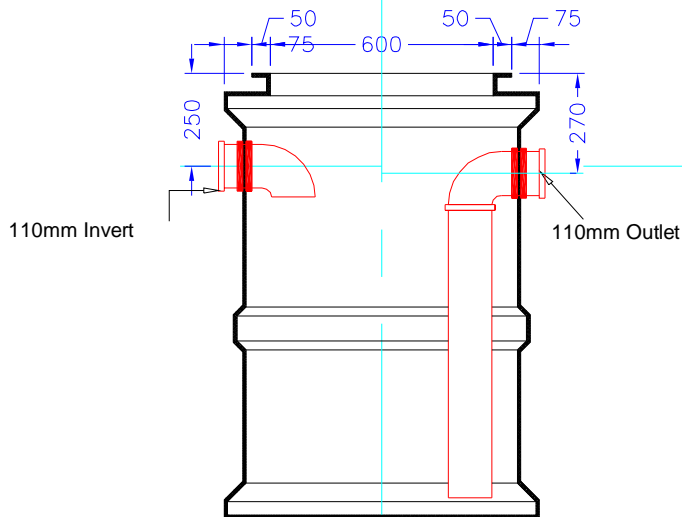

Section Through.

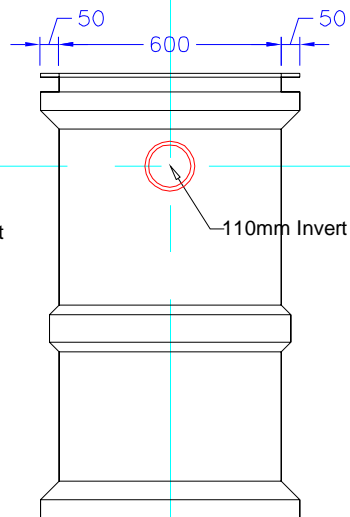

Elevation A.

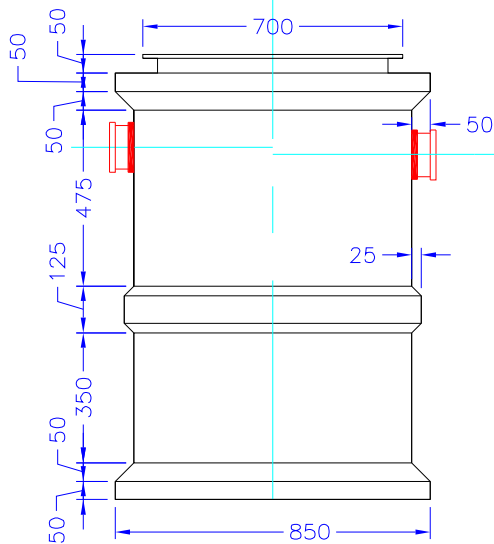

Side Elevation.

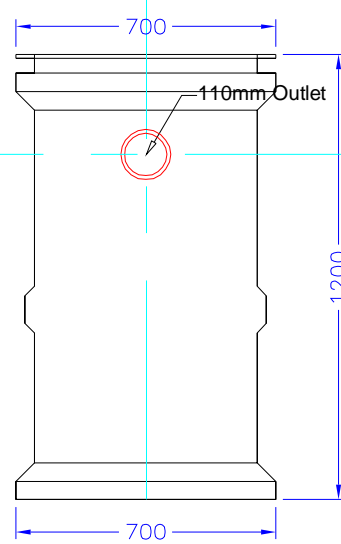

Elevation B.

Scale:	1:20
Drawn by:	R.G.W.
Date:	10-2003

Title:	Grease Trap 550 Litre	
Drawing No:	1063	Revision: